

Sink Happy Hour 49" x 20" – U/M



Kitchen Sinks

Code: 1049 950

AISI 304 Stainless steel

Satin finish

Undermount

x cross bending for easy water draining



DETAILS

Series	Happy Hour
Finish	Satin finish
Material	AISI 304 stainless steel
Thickness	16 Gauge (1.5 mm)
Inset type	Undermount
Overall dimensions	48 ⁵ / ₈ " x 19 ¹³ / ₁₆ "
Bowls dimensions	1 bowl 46 ⁵ / ₈ " x 15 ³ / ₄ "
Bowls depth	10 "

Cut out	46 ^{5/8} "x18 ^{3/4} "
Cut out warning	The specified cutout size is for POSITIVE REVEAL. This makes it possible to use all the foreseen levels for the accessories. In case of cutout at ZERO REVEAL, there would be no possibility to use the levels 0 and 1
Waste fitting type	3 1/2" - with stainless steel basket
Bowls bottom	X cross bending for easy water draining
Underside	Protected with heavy duty undercoating
Fixing system	Undermount fixing kit (brass insert and clips)

FEATURES

Diamond-shape bottom	The draining of water is an important feature in a sink, and it's always taken good care of in Foster products. In the bent-welded sinks, which would have a flat bottom, the proper draining is guaranteed by the elegant beveling, which helps the water flow.
High thickness	1.5 mm thick steel. A significant thickness, which guarantees the maximum sturdiness and durability.
Basket 3,5" waste fitting	The drain is equipped with a large 3.5" drain, with the practical basket cap that prevents the discharge of solid parts.
Triple recess - sliding accessories	The Foster Milano sink has an ingenious design that makes it simple to use a large set of optional accessories. On the topmost supporting step, the innovative Black grids slide, creating a large and practical surface to rinse food and crockery. The second step is meant to support and allow the sliding of a complete combination of accessories, which make some operations practical and safe: rinse, drain, slice, grate... everything can be done inside the sink. The third supporting step is on the bottom of the bowl. On this step one can rest the Black grids, making it possible to rinse foodstuffs without their coming in contact with the bottom of the sink, which may be dirty.

TECHNICAL DATA

Cutout for positive reveal (see Details)

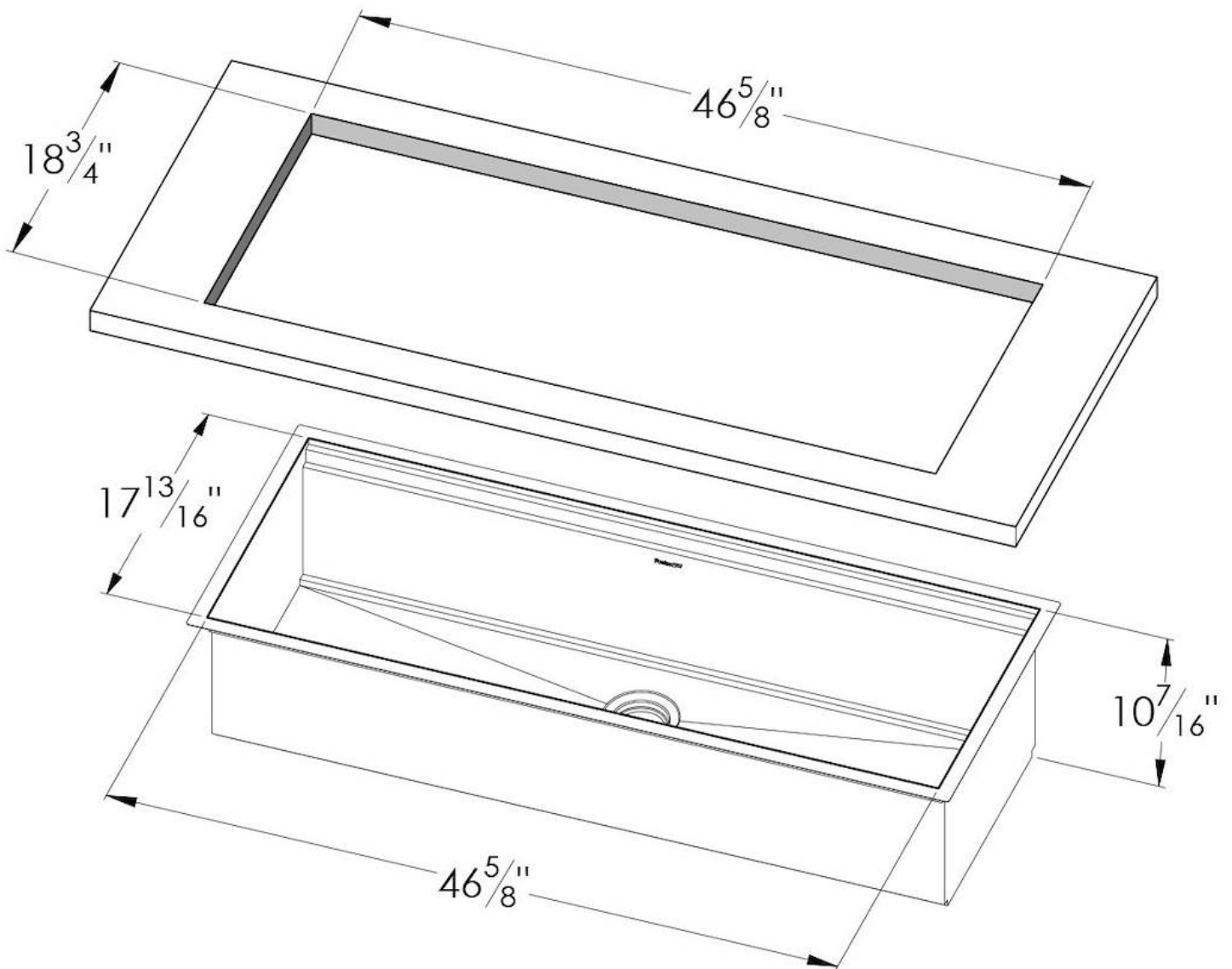

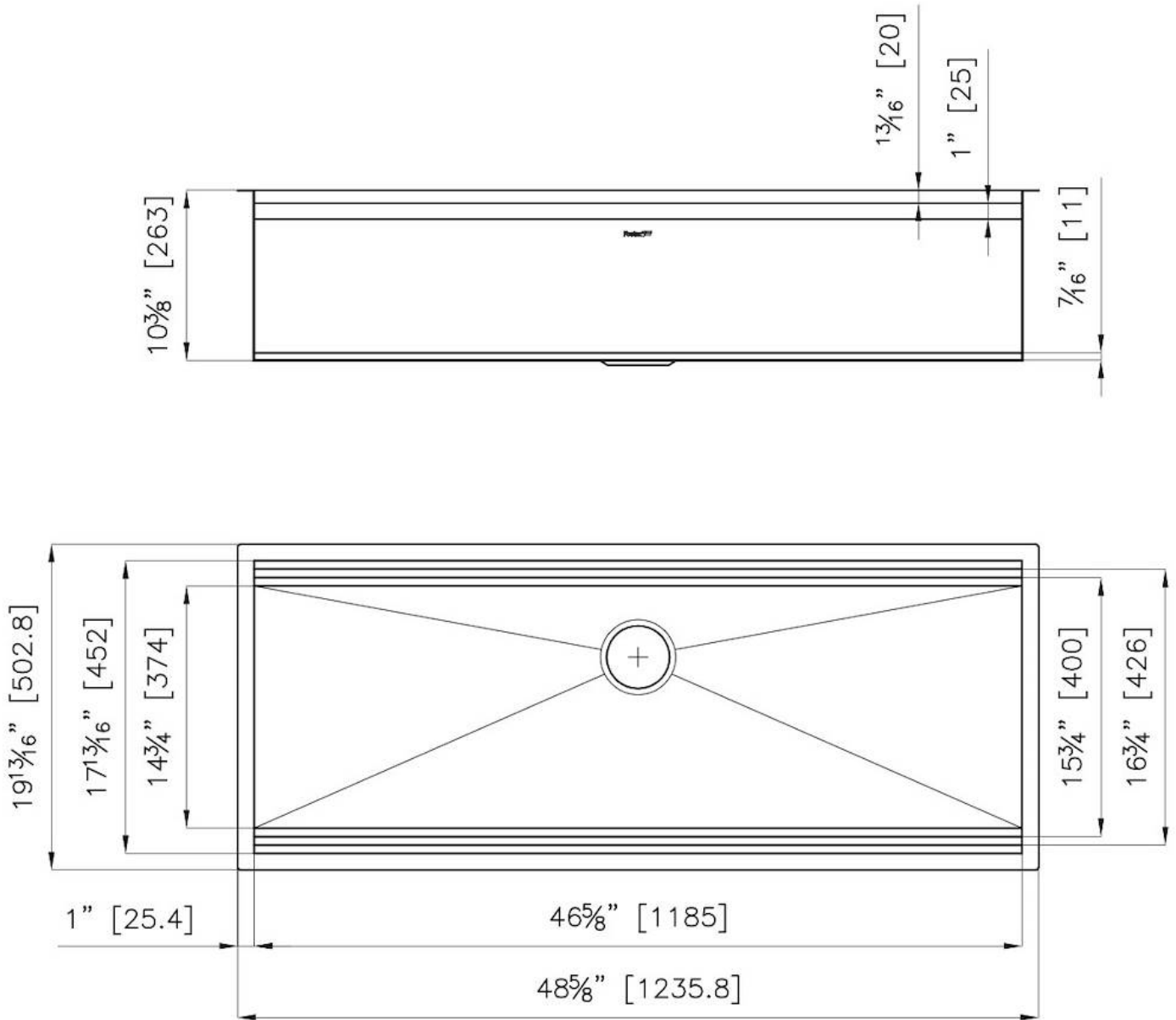

Happy Hour Optional accessories

The "rails" system makes it possible to use a combination of numerous accessories. Grids, chopping boards, utensils' ranging system, bowls and containers of different dimensions can be alternated in the workspace with a simple gesture, and can easily be stacked, in order to be on hand at all times.

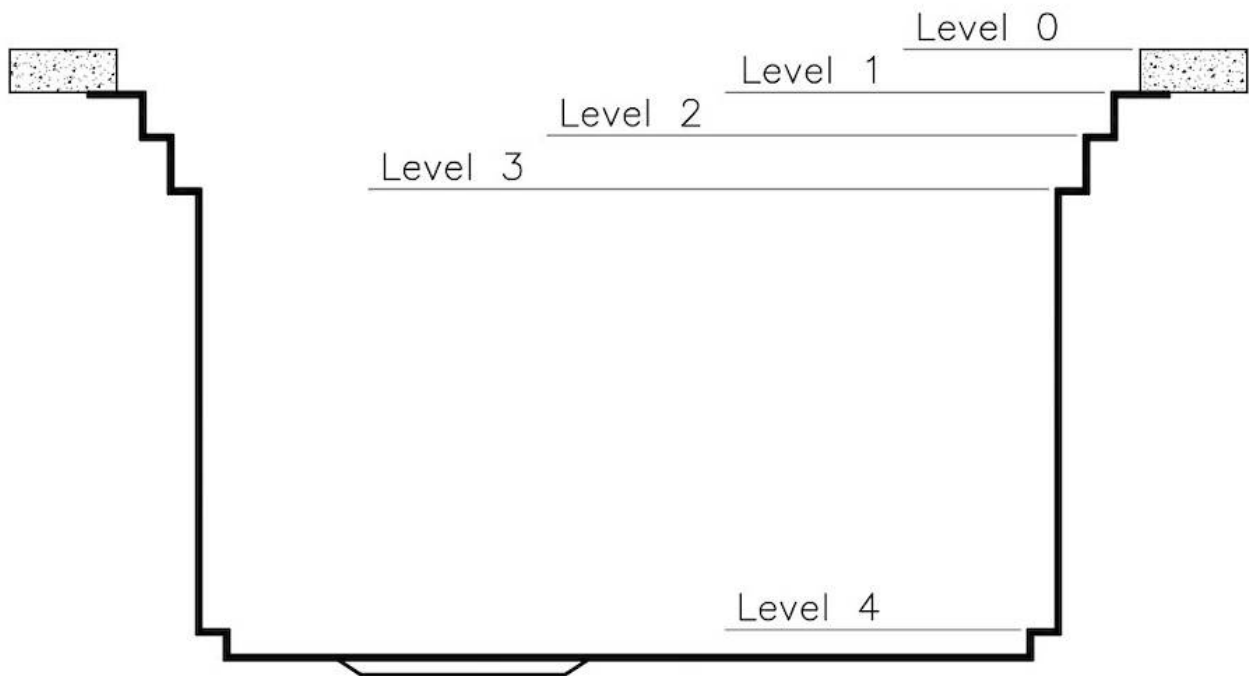

Happy Hour Level 0

Compatible accessories:

8200 002

8200 601



Happy Hour Level 1

Compatible accessories:

8100 625

8100 626

8100 627

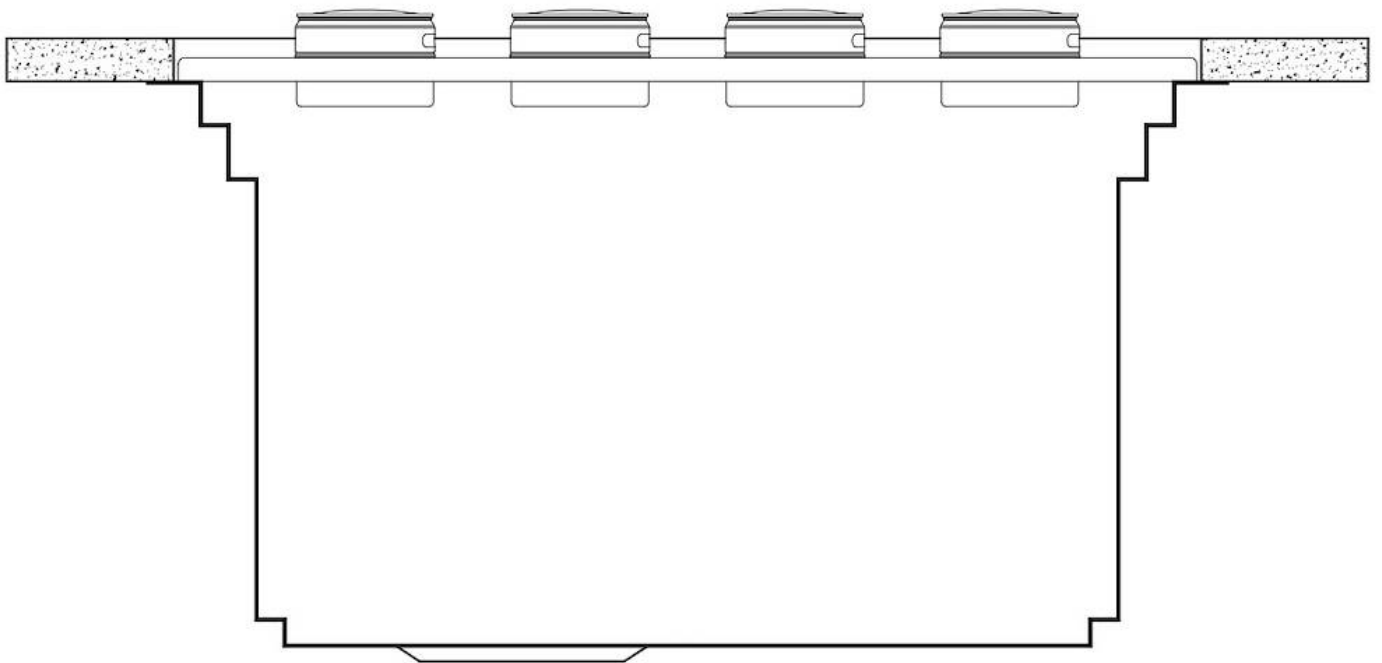

Happy Hour Level 2

Compatible accessories:

8100 600
8100 620
8100 621
8100 622
8100 628
8642 000

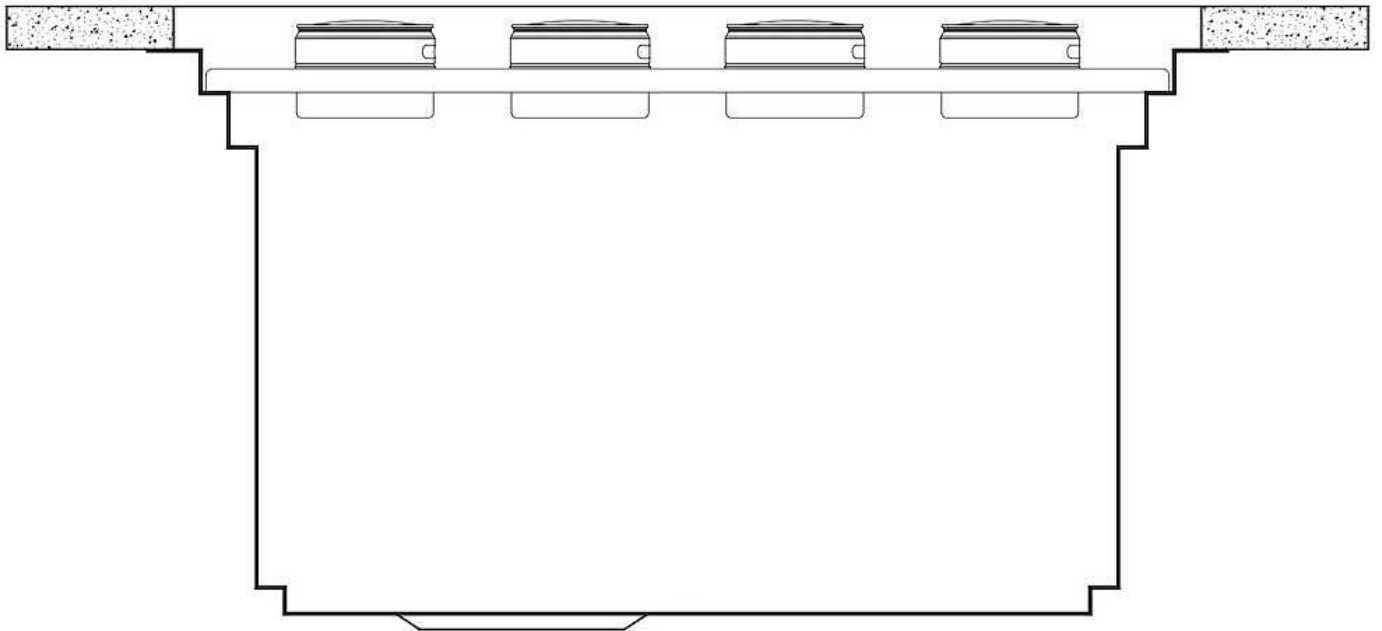

Happy Hour Level 3

Compatible accessories:

8644	101
8153	100
8631	300
8200	002
8200	601
8100	623
8100	624



Happy Hour Level 4

Compatible accessories:

8100 600



8100 600

8100 600

8100 600

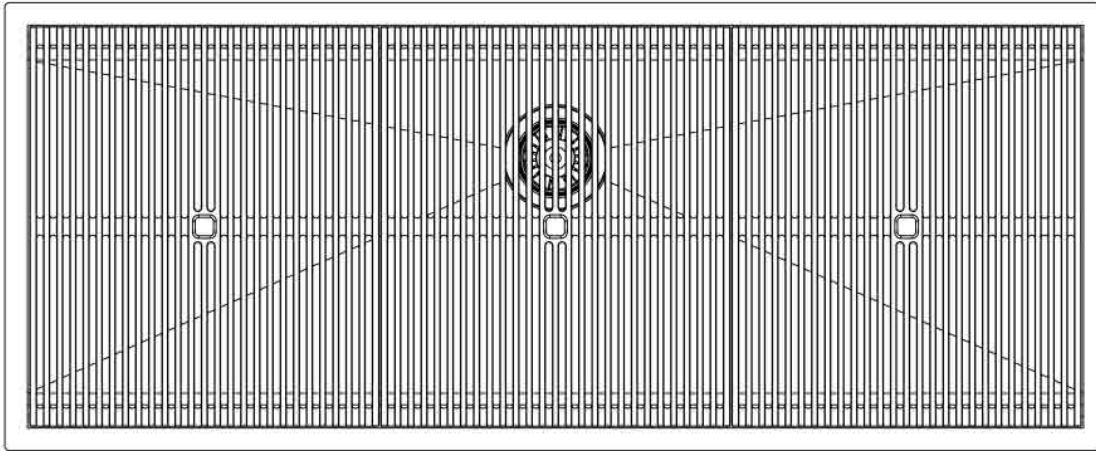

Edge positioning

Bottom positioning

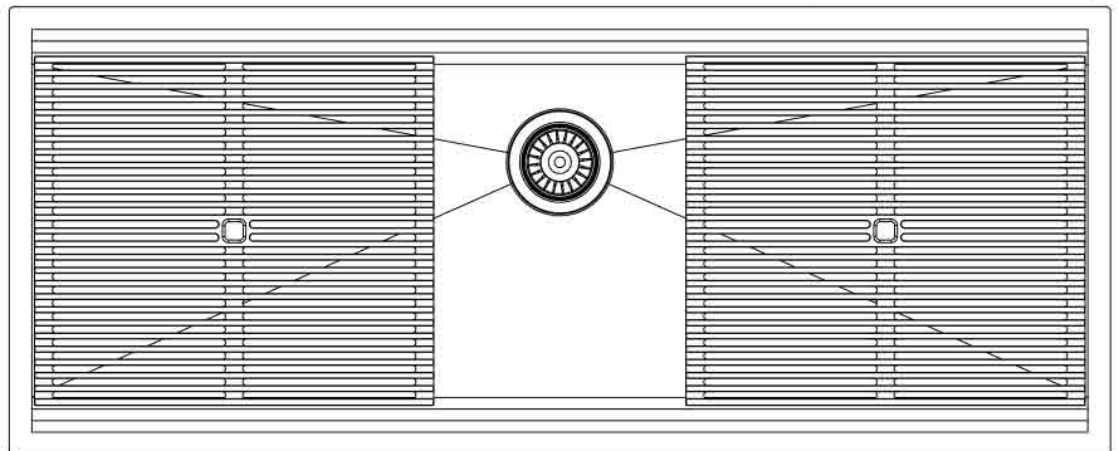

8100 600

8100 600

GALLERY

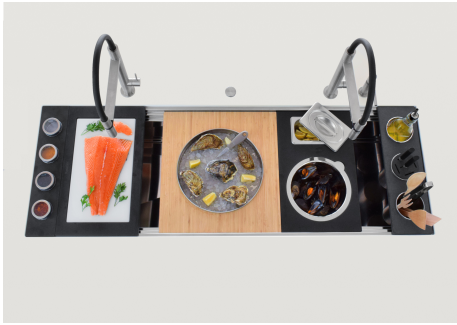
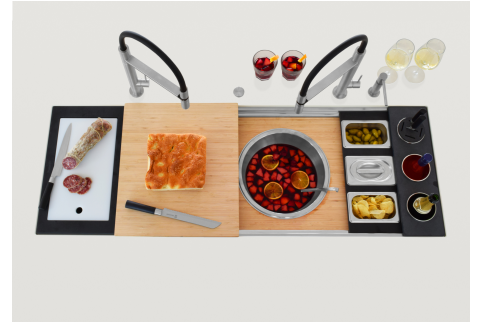

OPTIONAL ACCESSORIES



2 Bowls set
8100 623



3 Bottles-holder set
8100 621



3 Bottles-holder set
8100 626



3 Bowls set
8100 622



3 Bowls set
8100 624



4 Spices-holder set
8100 620



4 Spices-holder set
8100 625



Chopping Board
8642 000



Chopping Board
8631 300



Grating kit complete with ring support and food collection tray
8159 101

* only in combination with the accessory
8644 101 or 8100 627



HDPE + Black Twin chopping board
8100 627



Kit bowl Ø30 cm with bamboo support
8200 601



Kit multi-bowl
8100 628



Knives-holder
8100 030

* only in combination with the accessory
8100 621 or 8100 626

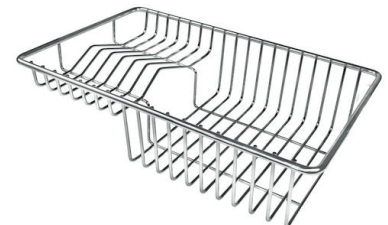

Stainless Steel dishes holder
8100 303

* only in combination with the accessory
8644 101 or 8100 627



Stainless steel perforated pan
8151 000

* only in combination with the accessory
8644 101 or 8100 627



Steel tray
1778 000

* only in combination with the accessory
8200 601



Twin Chopping Board
8644 101



White bowl
8153 100



Bamboo chopping board
8200 002



Black Grid
8100 600



Waste disposer throat
8669 043

RECOMMENDED PAIRINGS



Faucet Capri
8467 005



Faucet Salina
8487 005

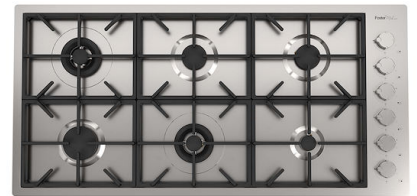

Milano Cooktop 6 burners
7639 900

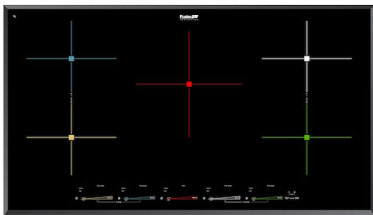

Milano Induction Cooktop 5 Plate
7390 945